

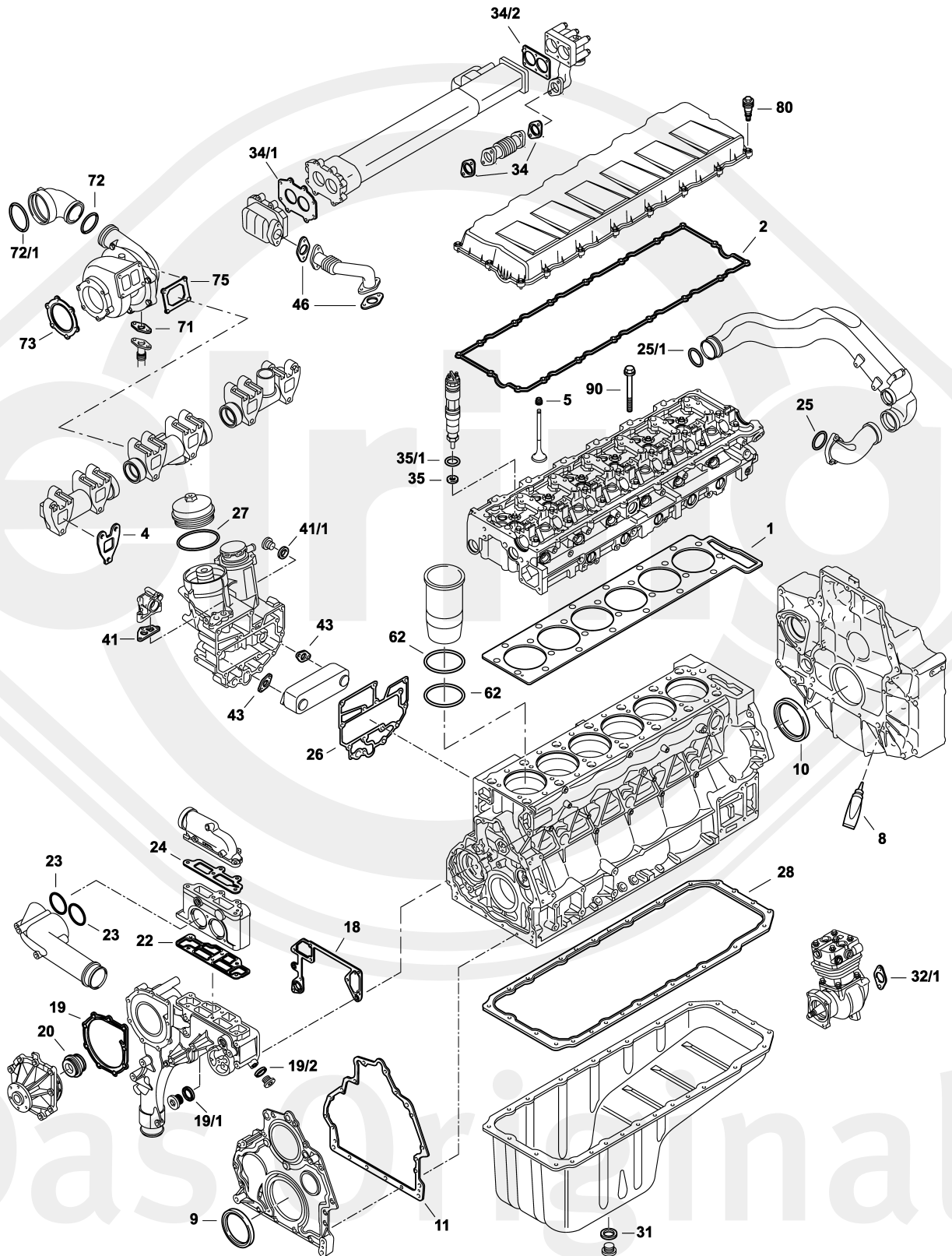

Das Original

MAN









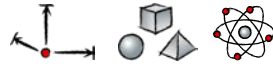



D 2066





D 2066 LF | LOH



S ⊕ *	198.610	1x	51.00900-6680	-	D 2066 LF01-04/6/7/11-16/21-39 
S ⊕ *	005.770	1x	51.00900-6708	-	D 2066 LF17-30  → XXX1414256XXXX 
S ⊕ *	005.780	1x	51.00900-6709	-	D 2066 LF17-30  → XXX1414257XXXX 
S ⊕ *	900.340	1x	51.00900-6692	-	D 2066 LOH 10/12
S ⊕ *	481.690	1x	51.00900-6794	-	D 2066 LF 51
S ⊕ *	884.250	1x	51.00900-6782	-	D 2066 LF 61
ES ⊕	195.080	1x	51.00900-6681	-	
ES ⊕	732.420	1x	51.00900-6711	-	D 2066 LF 17-30  XXX1414257XXXX → LF 51 
ZKHS	136.890	1x	-	-	D 2066 LF LOH
ZKHS	714.660	1x	-	-	D 2066 LF/LOH 430 PS (316kW) →
ZKS	124.791	1x	-	M18x2x246	26x 51.90020-0421
TLS	715.710	1x	-	-	D 2066 single turbo
TLS	996.560	1x	-	-	D 2066 for TL 51.09100-7907 
TLS	996.570	1x	-	-	D 2066 for TL 51.09100-7965 
1	021.262	1x	51.03901-0403	∅ 121 mm $\frac{\pm}{\mu}$ 1,2 mm	-
1	195.470	1x	-	∅ 121 mm $\frac{\pm}{\mu}$ 1,5 mm	-
2	141.522	1x	51.03905-0177	-	-
4	008.763	6x	51.08901-0170	-	-
5	814.882	24x	51.04902-0033	9x12/15,4x11 FPM	-
8	610.023	1x	04.10394-9272	310 ml	 Dirko™ HT 
9	158.510	1x	51.01510-0273	100x130x12 AW/BS RD PTFE/ACM	-
10	766.829	1x	51.01510-0206	120x140x13 AW/BS LD PTFE/ACM	-
10	354.090	1x	51.01510-0283	115x140x12 AW/BS LD PTFE/ACM	-
10/1	834.289	1x	51.02130-0013	115x120x21 FE	
11	021.432	1x	51.01905-0092	-	-



D 2066 LF | LOH



18	714.740	1x	51.06903-0061	-	-
19	021.250	1x	51.06901-0192	-	-
19/1	153.280	1x	06.56631-0111	24,7x32x2 FE/FPM A	-
19/2	153.270	1x	06.56631-0106	14,7x22x1,5 FE/FPM A	-
20	632.790	1x	51.06520-0085	-	-
22	021.411	1x	51.06904-0042	-	-
23	088.872	2x	06.56939-0094	60x4,2 EPDM RD	-
24	021.380	1x	51.06904-0039	-	-
25	152.830	1x	06.56936-2423	60x3 FPM RD	-
25/1		1x	06.56939-0071	56x4 EPDM RD	-
26	021.272	1x	51.05901-0160	-	-
27	845.870	1x	51.96501-0671	126x4 VMQ	-
28	492.520	1x	51.05904-0210	EWP/soft material	-
28	357.571	1x	51.05904-0239	Elastomer/Rubber/Caoutchouc/ Goma	-
31	153.260	1x	06.56631-0110	22,7x30x2 FE/FPM A	-
32/1	404.240	1x	51.96601-0548	EWP/soft material	-
34	021.370	2x	51.08901-0174	-	-
34/1	058.360	1x	51.08901-0195	-	-
34/1	906.280	1x	-	-	-
34/2	008.790	1x	51.08901-0172	-	-
35	293.140	6x	51.98701-0118	7,6x15x1,5 CU A	-
35/1	000.230	6x	51.96501-0502	20,9x3 FPM RD	-
41	896.190	1x	51.05901-0135	-	-
41/1	804.360	1x	06.56631-0109	18,7x26x1,5 FE/FPM A	-
43	759.296	2x	06.56254-2203	-	-
46	747.050	2x	51.08901-0120	-	-
62	152.230	12x	51.96501-0738	139,4x3,95x4,7 FPM RD	-
71	303.421	1x	51.96601-0576	-	-
72	060.150	1x	06.56936-2479	63x2,5 FPM RD	-
72/1	130.970	1x	06.56936-3004	86x5 FPM RD	-
73	155.570	1x	51.08901-0209	-	-
75	139.090	1x	51.08901-0182	-	-
77	898.580	2x	51.09905-0094	-	-
80	006.420	18x	51.96210-0080	-	-