

Cylinder-Head Gaskets

Everything for a Reliable Seal.



Das Original

Elring – Das Original

The success of the „Elring – Das Original“ brand is founded on the innovatory prowess and OEM expertise of ElringKlinger AG, a company employing more than 9,000 people at 49 sites around the globe. As a technology leader, the Group has established itself as a sought-after development partner and series supplier for cylinder-head and specialty gaskets, lightweight polymer components, shielding parts, and exhaust gas purification systems. The Group's portfolio also includes components for lithium-ion batteries and fuel cells as well as products made of the high-performance plastic PTFE. Specially designed ElringKlinger components for engine, exhaust system, underbody, chassis, and vehicle body applications are used by virtually all car and engine manufacturers as well as many automotive suppliers.

The Elring aftermarket brand offers an all-embracing package: original equipment quality, an extensive product range, outstanding functional reliability, and high-end services. Retail partners and auto repair workshops can look forward to professional support in the form of online catalogs, technical documentation, exploded view drawings for trucks and vans, extensive training and educational services, and access to the Elring Academy. This is complemented by hands-on installation videos, a monthly newsletter covering every aspect of engine sealing, and a service hotline designed to offer immediate assistance where required.

Original Elring products are acknowledged among dealers, mechanics, and customers around the globe. These products include cylinder-head and secondary gaskets, oil seals and valve stem seals, sealing compounds, as well as cylinder-head bolt sets and complete gasket sets.

FOCUS

- 04 Requirements and influences
- 05 Types
- 06 Metaloflex™ metal layer cylinder-head gaskets
- 08 Metal-elastomer cylinder-head gaskets
- 09 Metal/soft-material cylinder-head gaskets
- 10 Only new cylinder-head bolts are completely reliable
- 12 Engine damage – caused by the cylinder-head gasket?
- 13 Damage symptoms and causes of gas blow-by
- 18 Damage symptoms and causes of overheating
- 20 Damage symptoms and causes of oil and cooling leakage
- 23 Damage symptoms and causes of mechanical factors
- 24 Damage symptoms and causes of irregular combustion process
- 26 Professional installation of a cylinder-head gasket in seven steps
- 28 Selection of appropriate cylinder-head gasket for diesel engines
- 30 Elring-Service



Requirements and influences

Representing the very best in technological precision, cylinder-head gaskets are developed in close cooperation with the individual customers to whom they are supplied. The focus is very much on the engine as an overall system and on the interaction of all components involved. As a key component, cylinder-head gaskets contribute to the efficient, reliable, and economical operation of engines. They are designed to provide a high-end seal for combustion gas, coolant, and oil. As a power transmission element between the crankcase and the cylinder head, cylinder-head gaskets also have a major influence on force distribution within the bolted system as well as the resulting elastic deformation of components.

ElringKlinger boasts more than 135 years of experience in sealing technology. Committed to excellence, the company can draw on exceptional abilities as an innovator, unique knowledge within the area of materials, and extensive know-how in the field of high-precision metalworking (stamping, embossing, and forming) in combination with expertise relating to various coating methods and plastics engineering. As a technology leader, ElringKlinger places particular emphasis on state-of-the-art development and testing tools, e.g., analytical assessments of the entire sealing system or service life predictions for beaded elements using FEM.

Additionally, hardware simulations are performed to analyze wear mechanisms within the engine itself and with regard to the cylinder-head gasket, e.g., with the help of abrasion testing. Whether Metaloflex™, metal-elastomer, or metal/soft-material cylinder-head gaskets: ElringKlinger products meet the highest possible quality standards and deliver high-end performance and reliability even when exposed to extreme conditions such as high pressure levels and temperatures or aggressive substances.

REQUIREMENTS TO BE MET BY CYLINDER-HEAD GASKETS

- Gas tight
- Coolant tight
- Oil tight
- Ductile
- Dynamic
- Retorque-free
- Low distortion
- Resistant to chemical influences of combustion gases, lubricants, and coolants
- Durability

INFLUENCES ON THE CYLINDER-HEAD GASKET

Combustion gas temperature

+1,800 °C - +2,500 °C

Temperatures in the cylinder head area

Gasoline engines ≤ 270 °C

Diesel engines ≤ 300 °C

Combustion pressure

Gasoline engines ≤ 140 bar

Diesel engines ≥ 270 bar

Deformation

Due to the ignition pressure in each ignition process, the sealing gap is deformed by 2 - 10 µm in the direction of the stroke; bending of the cylinder head and the cylinder tube also causes transverse sliding movements, depending on bolt arrangement and dimensioning

Materials

Thermal stresses cause additional sliding movements; sealing surfaces on the cylinder head/engine block made of aluminum alloys, gray cast components also possible

Surface roughness

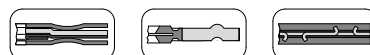

R_z 15 - 20 µm 11 µm 11 - 20 µm

R_{max} 20 - 25 µm 15 µm 15 - 20 µm

Coolant and lubricant

Water-antifreeze/anticorrosive mixture

+80 °C - +110 °C; pressure 1 - 2 bar

Engine oil +80 °C - +150 °C; pressure 2 - 4 bar (warm) to 10 bar (cold)

Special design features

e.g., in reciprocating engines, combustion chamber, coolant channel

Types

Cylinder-head gaskets are available in three designs: Metaloflex™, metal-elastomer, and metal/soft material for various types of engine.

METALOFLEX™ METAL LAYER CYLINDER-HEAD GASKETS



METAL-ELASTOMER CYLINDER-HEAD GASKETS

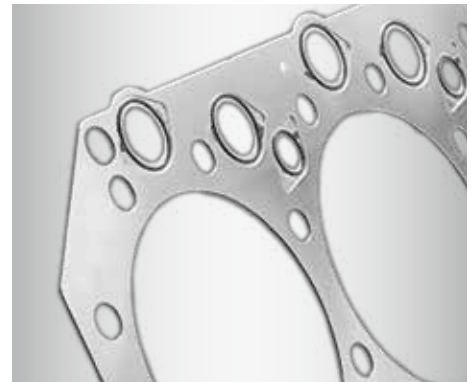
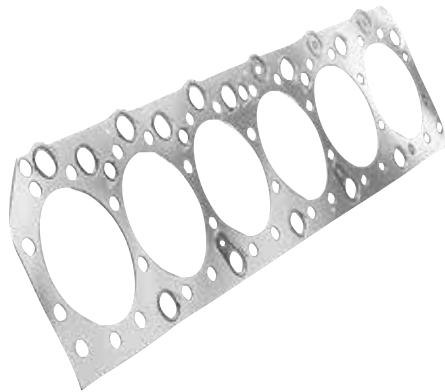

METAL/SOFT-MATERIAL CYLINDER-HEAD GASKETS

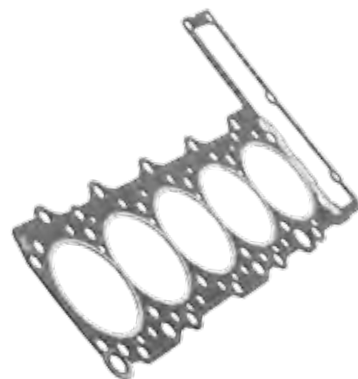

Metaloflex™ metal layer cylinder-head gaskets

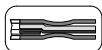

Metaloflex™ metal layer cylinder-head gaskets consist of beaded spring steel layers. Depending on their area of application, they are of a single-layer or multilayer design. Due to the modular design with functional elements comprising the coating, bead, and stopper, they can be tailored fully to a specific engine design.

With an annual production output of around 45 million units, ElringKlinger is acknowledged as one of the world's leading manufacturers of metal layer cylinder-head gaskets. This type of gasket is used in all modern cars and vehicles equipped with range extenders as well as small and medium-sized vans and commercial vehicles. Trends such as engine downsizing, light-weighting, selective cylinder deactivation, and hybrid technology have increased the demands placed on cylinder-head gaskets. Due to the reduced wall strength and lower rigidity of today's components, together with the fact that such parts are exposed to higher temperatures and ignition pressures, sealing concepts as a whole have to be particularly efficient and tailored precisely to the specific task.

The technological superiority of this solution is particularly evident in the case of diesel engines and high-performance gasoline engines with direct injection:

- Metal technology
- Elastic sealing with beads for macro sealing
- Elastomer coating for micro sealing
- High thermal stability
- Compensation of high dynamic sealing gap oscillations
- Variable installation thicknesses, dead space minimization

STOPPERS

Around the perimeter of the combustion chamber, engine components are elastically pre-stressed by the stopper. This brings about a reduction in sealing gap oscillations caused by the force of the gas. ElringKlinger has a track record of excellence in all technological fields, be it laser-welded stoppers, folded stoppers, or coined/embossed stoppers. Here a basic distinction is made with regard to the functional layers (segment, serpentine, dimple) and the carrier plate (honeycomb).

HALF BEADS

Half beads generate two-line compression. They provide a seal along the coolant and engine oil passages, along the bolt holes, and all around the outer gasket contour.

FULL BEADS

Full beads generate three-line compression around the perimeter of the combustion chamber. Thanks to this elastic sealing element, it is possible to tackle very high ignition pressures, even when subjected to significant dynamic sealing gap oscillations.

FUNCTIONAL LAYERS

These elastomer-coated spring steel layers feature elastic beads.

CENTER LAYER

The main function of the center layer is to adapt the gasket thickness to the installation conditions required by the overall design.

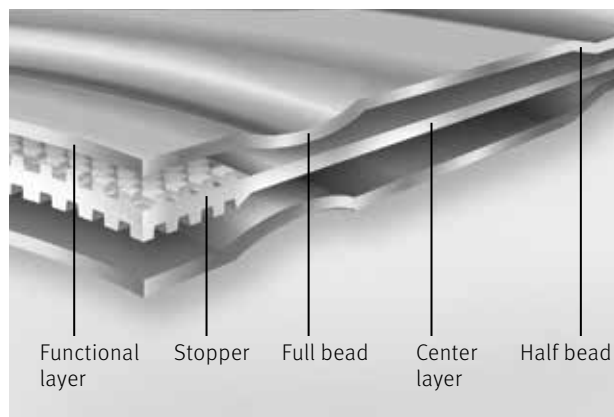

COINED STOPPERS

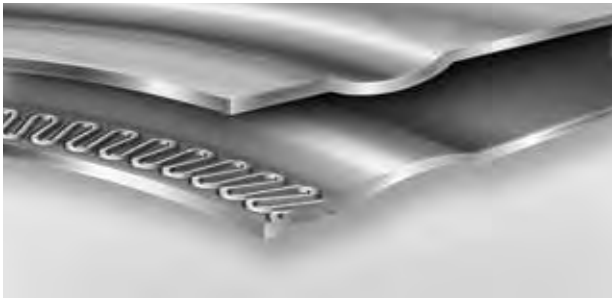

Serpentine stopper in functional layer

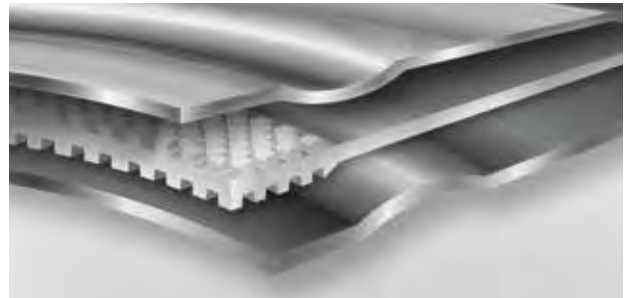

Honeycomb stopper in center layer

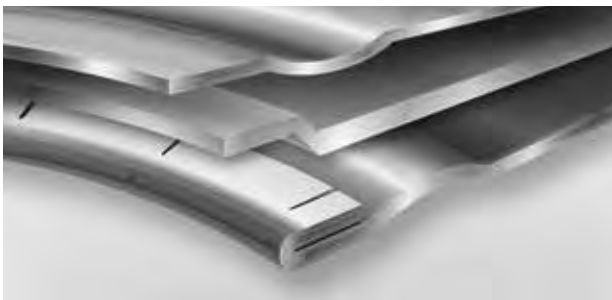

Segment stopper in functional layer

LASER-WELDED STOPPERS

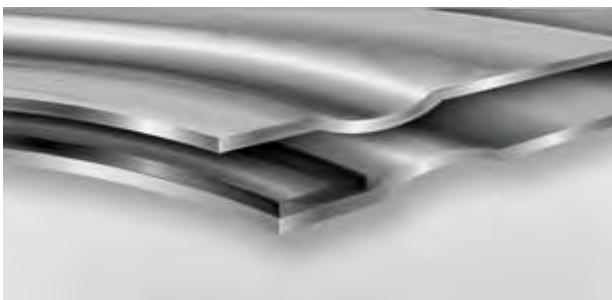

Without carrier plate

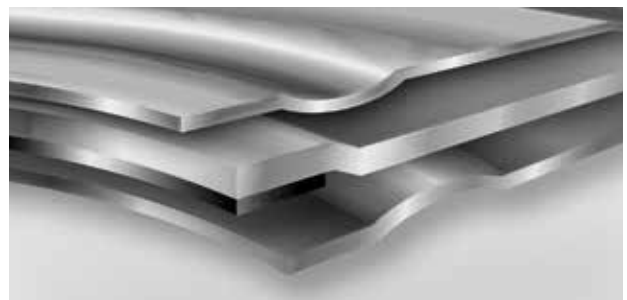

With carrier plate

FOLDED STOPPER LAYER

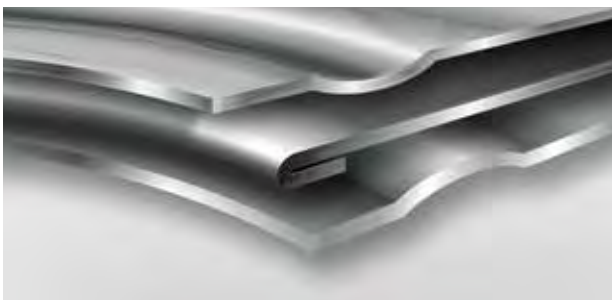

Without carrier plate

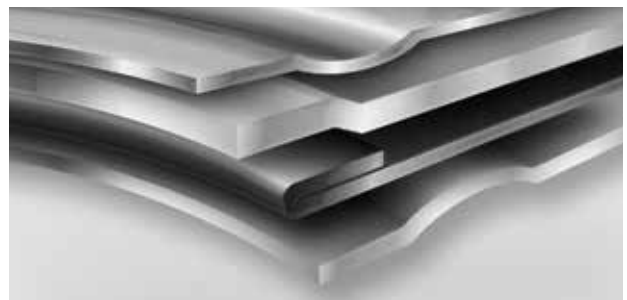

With carrier plate

Metal-elastomer cylinder-head gaskets

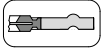

ElingKlinger metal-elastomer cylinder-head gaskets consist of metal carriers with vulcanized elastomer profiles. This gasket technology is used primarily in high-performance engines within the commercial vehicle sector – with turbocharging and intercooling. It is tailored in particular to innovative drive concepts with four-valve technology, modern injection systems, lightweight design, higher ignition pressures, and maximized engine power. Ignition pressures of up to 290 bar, engine power ratings in excess of 2,000 kW, and engine mileages of more than 1.5 million kilometers pose no problem whatsoever. These high-performance characteristics are attributable to the specific sealing pressure distribution in the areas of engine block and cylinder head. The sealing pressure is high in the vicinity of the combustion chamber, while it is low in the fluids area.

ELASTOMER SEALING LIPS

They take care of cooling water and oil sealing. The materials and geometry are adapted to the particular engine. Applying this metal-elastomer design, it is also possible to seal narrow sealing webs.

CARRIER LAYER

Depending on the requirements of the engine, the carrier layer uses corrosion-protected steel grades, micro-alloyed steels, stainless steel, or a special-purpose spring steel in the multilayer version.

In the combustion chamber area it features a bead that, together with the combustion chamber underlay (in the single-layer version) or together with the combustion chamber eyelets (in the multilayer version), defines the installation thickness and handles gas sealing. The elastomer sealing lips are directly vulcanized onto the part, whereas the combustion chamber eyelets and supports are mounted.

COMBUSTION CHAMBER EYELETS AND COMBUSTION CHAMBER UNDERLAY

The combustion chamber eyelets and combustion chamber underlay (in the multilayer version) use their specific thickness to regulate bolt force distribution to the combustion chamber, elastomer sealing lip, and support.

By means of the combustion chamber eyelets or combustion chamber underlay the installation thickness of the cylinder-head gasket in the combustion chamber area is raised slightly relative to the rest of the sealing area. Sealing pressure increases at the combustion chamber, which, together with the combustion chamber bead, accomplishes gas sealing. For the purpose of micro sealing, a thin, organic coating is applied to the surface.

COMBUSTION CHAMBER BEAD

Designed as a full bead, the combustion chamber bead brings about an increase in sealing pressure in the form of a line contour. In the single-layer version the bead provides a static seal. An elastic bead made of spring steel provides homogeneous sealing pressure along the edge of the combustion chamber in the multilayer version. The latter is capable of following dynamic sealing gap movements. In this design the bead is located directly below the combustion chamber eyelets and hence in the main frictional interface between the cylinder head and the engine block.

Single-layer solution

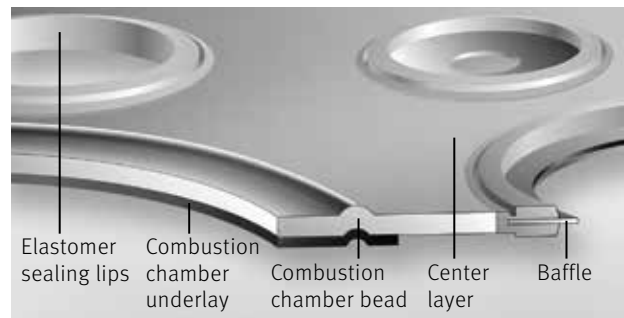

BAFFLE

Vulcanized baffles with various flow cross-sections are used for the purpose of controlling coolant flows.

Multilayer solution

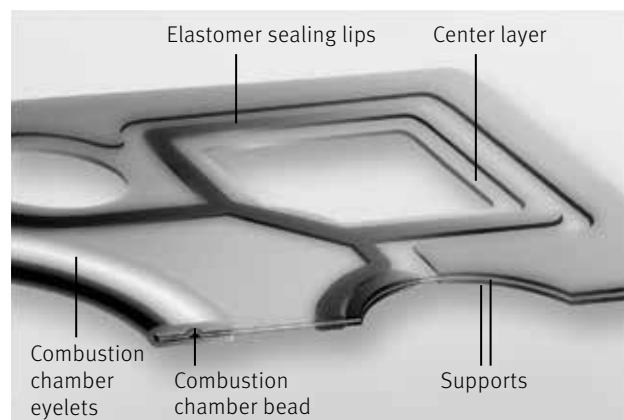

SUPPORTS

The metal supports that are used especially in multilayer versions help to restrict cylinder head flexing and also protect the elastomer sealing lips against excessive levels of compression.

Metal/soft-material cylinder-head gaskets

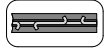

ElringKlinger metal/soft-material cylinder-head gaskets consist of a serrated carrier plate with a soft lining rolled onto both sides. The combustion chamber opening is equipped with metal eyelets. This increases compression in the combustion chamber and protects the soft material against hot combustion gases. If required, a linear elastomer coating is applied in order to provide a fluid seal. That creates higher localized compression and thus optimal adaptation of the sealing surface to surface roughness. Elastomer elements are used particularly in pressurized oil systems if the engines are subjected to higher dynamic loads. Complete surface coatings prevent sticking and ensure micro sealing.

The key strengths of metal/soft-material cylinder-head gaskets are as follows:

- Adaptation to engine components through soft-material sheets
- Increase in compression and provision of thermal protection through metal eyelets around the combustion chamber
- Additional reliability in fluid sealing due to silicone screen printing

Due to the expanded functionality of the Metaloflex™ and metal-elastomer designs, this type of gasket is hardly ever used anymore in next-generation engines. Having said that, the metal/soft-material cylinder-head gasket will continue to play a key role in the repair and servicing of used engines for many years to come.

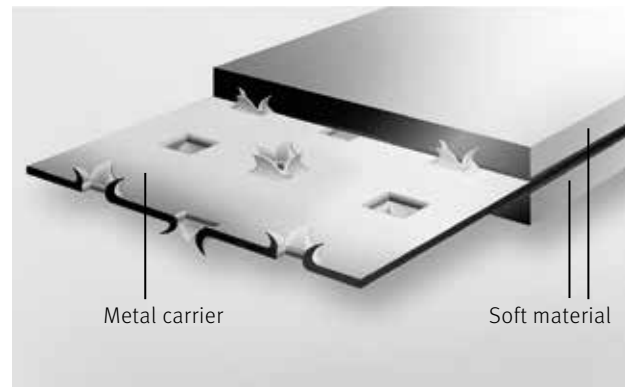

Only new cylinder-head bolts are completely reliable

Next-generation engines come with improved sealing concepts that have been adapted to the specific engine designs. In order to ensure an extended service life of such units, it is imperative that the original condition of the engine in question is reproduced when carrying out repairs to the cylinder head. In this context, the cylinder-head bolts are of prime importance. Cylinder-head bolts are key components within the overall system when it comes to generating the requisite force to be applied to the cylinder-head gasket for sealing purposes. They ensure that the necessary compression forces are suitably distributed across the cylinder-head gasket irrespective of the state of operation. This can only be achieved with a new cylinder-head gasket in combination with new cylinder-head bolts.



What is more, the new cylinder-head bolts must be tightened in accordance with the methods and procedures developed by engine and gasket manufacturers. The key characteristics of such bolts are best exploited if the appropriate torque and angle of rotation are observed. The bolts are tightened to a point beyond their yield strength until they enter the stage of plastic deformation.



Used bolts and bolts with evidence of elongation (coinciding with a reduction in the cross-section of the shaft and thread) no longer have the same properties as new bolts in respect of strength and elasticity. This in turn will lead to an impairment in the consistent distribution of tensile forces and elasticity within the bolt shaft, which are essential in the field of modern engine design when it comes to compensating for component elongation and any relative movements. Additionally, used bolts show signs of deformation in specific sections of the thread due to the high bolting forces (see image on the right). In their original state, the threads have a tolerance of 6 μ , which is in the hundredths of millimeter range. They no longer meet these specifications once they have been used. Cylinder-head bolts also have a specially developed surface coating to ensure favorable friction characteristics below the head section and within the threaded area. Only new bolts can achieve the requisite coefficient of friction of 0.12 – 0.14 μ .

For professional repairs, therefore, specifications issued by the engine and gasket manufacturer must be observed at all times. The gasket will only be fit for purpose if these standards are met in full:

- Use a new cylinder-head gasket and new cylinder-head bolts
- Observe required torque and angle of rotation
- Follow correct sequence for tightening bolts
- Use distortion-free engine components
- Only allow qualified personnel to perform such work
- Use high-precision tools only

Under no circumstances should used or non-compliant bolts be installed. Only by following these strict guidelines can subsequent damage, e.g., as a result of leaks, be avoided – together with the risk of additional repair costs, dissatisfied customers, and a loss of image within the market.

Elring's end-to-end range of cylinder-head bolts is designed to save time and money. We are able to offer you everything you need from a single source: the cylinder-head gasket and the matching set of cylinder-head bolts.

- Tested quality for the majority of cars and commercial vehicles
- One set for each engine repair job
- Packaged in specially designed box with thread protection
- Fast and simple ordering via Elring



Engine damage – caused by the cylinder-head gasket?

Actual causes and remedial measures

In the case of engine failures the cause is often wrongly sought in the cylinder-head gasket. From the perspective of a mechanic, this is fully understandable because the assumption is that the gasket has been installed carefully in compliance with the repair instructions.

THE HIDDEN REAL CAUSES

If you analyze practical cases over many years, the situation becomes clear: the root causes of engine damage are often completely different. A cylinder-head gasket is usually the last link in the chain to show signs of damage – when it can no longer completely fulfill its actual task of stopping leaks. Consequently, the cylinder-head gasket is finally returned to the manufacturer as a damaged part subject to complaint.

What possible leaks can occur in cylinder-head gaskets?

As regards leaks in the seals of a cylinder head, the substances involved are usually

- Gas
- Water
- Oil

TYPES OF GAS LEAKS

- From one combustion chamber to the adjacent combustion chamber via the sealing web
- From the combustion chamber to the cooling circuit

These leaks normally cause considerable damage and ultimately destroy the seal. Depending on the load on the engine, this can take place suddenly or only after a certain length of time.

TYPES OF WATER LEAKS

- From the inside to the outside
- To the oil circuit
- To the combustion chamber

TYPES OF OIL LEAKS

- From the inside to the outside
- To the cooling water circuit

Taking warning signals seriously and acting on them

If you discover irregularities in operation of the engine, e.g. poor cold-start performance, engine fails to run on all cylinders after a cold-start, loss of power, cooling water temperature in the red zone, oil in the cooling water, etc., you should take appropriate action without delay. At this stage it is still possible to prevent major engine damage.

IMPORTANT

First establish the cause before having the repair done. It is absolutely essential to refer to the engine manufacturers' general installation instructions. Otherwise the damage can occur again if the repair has not been performed properly.

Damage symptoms and causes of gas blow-by

Black discoloration is a clear symptom

Over-blow of combustion gases at the combustion chamber eyelets of the cylinder-head gasket is one of the most common causes making it necessary to disassemble the cylinder head.

A clear indication is visible black discoloration on the metal eyelets or in the adjacent soft-material area of the gasket. Due to the high gas temperatures, the soft material at these points is overheated and can even burn. The gases often find their way into the cooling circuit. This is indicated by rising gas bubbles in the radiator or by the cooling circuit overheating (pressure in the cooling circuit increases and coolant escapes from the pressure relief valve, resulting in loss of coolant). In the worst case the eyelet is completely destroyed as a result. Uniform discoloration of the combustion chamber eyelets, however, can be regarded as normal and depends on the steel material and the surface coatings used.



Most common causes

In many cases, insufficient compression of the gasket in this area, which is subjected to very high temperatures, is a possible cause. This can be brought about, for example, by failure to subject the cylinder head to the specified tightening torque, failure to comply with the installation guidelines, or the use of old bolts. Components that are not flat (deformed) or have surfaces that are too rough also contribute to insufficient compression of the gasket. Unusually high engine loads in operation can also result in excessive thermal stress for the combustion chamber seal and consequently destroy it.

AN EXAMPLE

Full-load operation directly after a cold start causes extreme sliding movements between the crankcase (gray cast iron) and the cylinder head (aluminum), subjecting the gasket to extreme stress. In addition, the preload forces of the cylinder-head bolts under these conditions are low, thus increasing the dynamic sealing gap movements toward the crankcase and cylinder head.

Very often, especially in the case of truck engines, the specified liner protrusion is not provided – due to lack of knowledge – or is adjusted incorrectly due to installation errors, the liner seating surface in the engine block was not reworked or the liner was not pressed into place properly. That causes the liners to drop, and the required sealing compression is lost. Combustion gases are now able to enter the rear areas of the gasket, where they then destroy the elastomer sealing elements or the soft gasket material in the water and oil openings.



Damage symptoms and causes of gas blow-by

1. Failure of the cylinder-head gasket on commercial vehicles due to gas blow-by

DAMAGE SYMPTOMS

Between cylinders 2 and 3 (exhaust area) there is considerable gas over-blow. The soft material of the gasket has been destroyed in the area of the water holes.



CAUSE

The cylinder-head gasket was not compressed sufficiently because the bolts were not tightened in compliance with the method specified by the manufacturer. That caused gas blow-by into the cooling water. The result was an increase in coolant pressure, loss of coolant and destruction of the cylinder-head gasket.

OTHER POSSIBLE CAUSES

- Cylinder liner has dropped
- Components have become distorted
- The surfaces of the engine components, i.e. cylinder crank case and cylinder head, became too rough
- Cylinder-head bolts used were not new or were of insufficient quality

MEASURES

Always use new cylinder heads for reasons of quality and safety. Tighten cylinder-head bolts with the required tightening torque as specified by the manufacturer. Follow the general installation instructions issued by the engine manufacturers.

DAMAGE SYMPTOMS

The elastomer sealing element has become detached from the gasket carrier at the tappet opening. The same has occurred at the water opening, thus causing a significant loss of water.

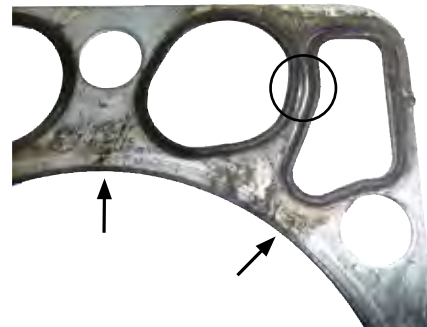

CAUSE

An uneven cylinder head surface caused gas blow-by. The elastomer sealing elements were pushed away from the carrier plate by the high gas pressure. The destructive process was accelerated by constant full-load operation of the engine.

OTHER POSSIBLE CAUSES

- Insufficient torque on the cylinder-head bolts
- Liner protrusion not adjusted properly
- Cylinder head surface not flat
- Problems in the injection system

MEASURES

Before installation, carefully check to make sure the component sealing surfaces are flat; have them faced by a qualified contractor if necessary. Follow the general installation instructions issued by the engine manufacturers.

2. Failure of the cylinder-head gasket on passenger cars due to gas blow-by

DAMAGE SYMPTOMS

Combustion chamber sealing web between cylinders 1 and 2 burnt through.

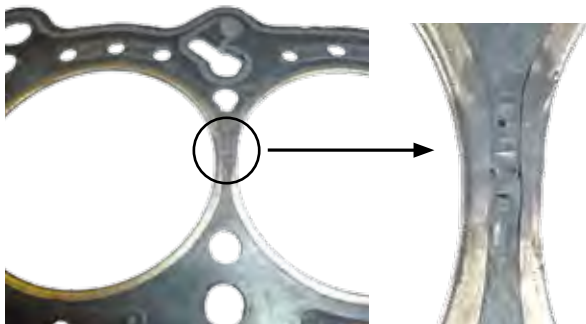

CAUSE

The gasket was not compressed sufficiently in the destroyed section because of non-compliance with the specified bolt tightening torque and because the old cylinder-head bolts were used, resulting in gas blow-by. Overheating then destroyed the sealing web.

OTHER POSSIBLE CAUSES

- Engine components not flat; sealing webs deformed on the engine block and cylinder head
- Engine not properly adjusted, resulting in overheating

MEASURES

During installation, make sure the required installation specifications are observed.

DAMAGE SYMPTOMS

Combustion chamber sealing web and soft material between cylinders 3 and 4 are scorched. Onset of dark discoloration between cylinders 3 and 4.

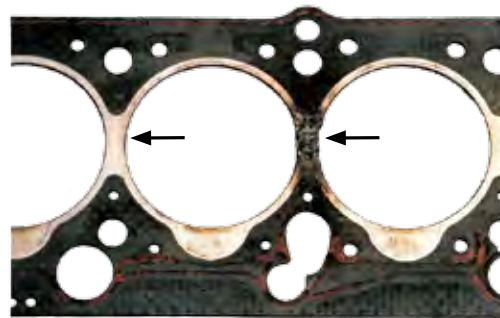

CAUSE

Uncontrolled combustion process caused the gasket material to overheat and ultimately destroyed it.

MEASURES

Before installation, inspect the injection nozzles carefully and check to make sure they are not leaking. After installation, check injection adjustment. Follow the general installation instructions issued by the engine manufacturers.

Damage symptoms and causes of gas blow-by

3. Failure caused by gas blow-by on 2-layer metal gasket for motorcycles

DAMAGE SYMPTOMS

The metal stopper layer and the functional layer show significant black discoloration near the cooling duct. Gas has leaked between the stopper layer and the functional layer.



CAUSE

Inadequate clamping forces due to insufficient bolt tightening torque, thus causing insufficient sealing compression.

OTHER POSSIBLE CAUSES

- Engine components not flat (deformed by overheating)

MEASURES

During installation, ensure that the specified bolt tightening torque is applied.

4. Failure due to pressure build-up in the cooling system as a result of gas blow-by

DAMAGE SYMPTOMS

On the multilayer metal cylinder-head gasket, distinct linear impressions can be seen in the area of the water ducts. These originate from the cylinder-head sealing surface and run toward the combustion chamber. The water passages are distinctly light-colored.



CAUSE

The surfaces of the cylinder head were machined either insufficiently or not at all. This resulted in blow-by of combustion gases into the cooling circuit and overheating (pressure build-up).

OTHER POSSIBLE CAUSES

- The cooling system was not completely vented, thus preventing the circulation of coolant
- Cooling circuit interrupted (water pump, thermostat, fan)
- High exhaust back pressure caused the engine to overheat (e.g. defective catalytic converter)

MEASURES

Before installation, check the condition of the sealing surface very carefully and make sure the cylinder head and cylinder block are flat. Have them faced by a qualified contractor if necessary.

5. Failure of the cylinder-head gasket due to pressure build-up in the cooling system as a result of gas blow-by

DAMAGE SYMPTOMS

Clear linear impressions can be seen around the media openings. These originate from the cylinder-head sealing surface and run toward the combustion chamber.



CAUSE

The surface structure of the cylinder head was either machined too coarsely or not at all. This caused combustion gas blow-by into the cooling circuit and overheating (pressure build-up).

OTHER POSSIBLE CAUSES

- The cooling system was not completely vented, thus preventing the circulation of coolant
- Cooling circuit interrupted (water pump, thermostat, fan)
- High exhaust back pressure caused the engine to overheat (e.g. defective catalytic converter)

MEASURE

Before installation, check the condition of the sealing surface very carefully and make sure the cylinder head is flat. Have it faced by a qualified contractor if necessary.

Damage symptoms and causes of overheating



Destructive heat

In many cases, damage to cylinder-head gaskets induced by overheating is caused by an engine component that stops functioning. This can be the water pump, a thermostat that does not open, or a radiator clogged with lime deposits (no circulation). However, insufficient water in the cooling system or an improperly vented cooling circuit after the installation of the cylinder head can also be the cause.

Nevertheless, it may be necessary to also consider other destructive factors that were taken into account during initial damage analysis.

For instance, the exhaust system can also be responsible for overheating. A loose component in the muffler or a melted catalytic converter can, for example, lead to a constricted exhaust duct cross section. This increases the exhaust back pressure and causes engine parts and the cylinder-head gasket to overheat. The result is a loss of engine power.

A cylinder-head gasket that has failed due to overheating, for example, is very easy to recognize because of warped soft material in the direct vicinity of the water passages.

If the cooling system overheats, coolant penetrates the soft material matrix of the gasket, where it evaporates due to the adjacent hot engine components and detaches the soft material from the metal carrier. That causes waviness in the material.

One should not underestimate the consequences of using antifreeze and anti-corrosion agents that have not been approved. Additionally, only absolutely pure water may be used as a coolant. The metal carrier plates of the gasket suffer massive decomposition as a result of corrosion, resulting in destruction of the gasket.

1. Failure caused by overheating in the 2-layer metal gasket

DAMAGE SYMPTOMS

In this type of gasket the metal functional layer is integrated into the combustion chamber seal. Here it is broken in the area of the sealing web. Significant black discoloration is a sign of over-blown combustion gas.



CAUSE

Component distortion resulted in over-blown combustion gases. The resulting overheating destroyed the metal layer.

OTHER POSSIBLE CAUSES

- Low quality fuel (insufficient octane rating)
- Compression ratio too high
- Engine tuning (sparkplugs with incorrect heat rating)
- Insufficient bolt preload force (bolt quality, bolt tightening)

MEASURES

Before installation, check the condition of the sealing surface very carefully and make sure the cylinder head is flat. Have it faced by a qualified contractor if necessary.

2. Failure caused by overheating of the metal/soft-material cylinder-head gasket

DAMAGE SYMPTOMS

The exposed soft material on the gasket is heavily swollen around the water passages.

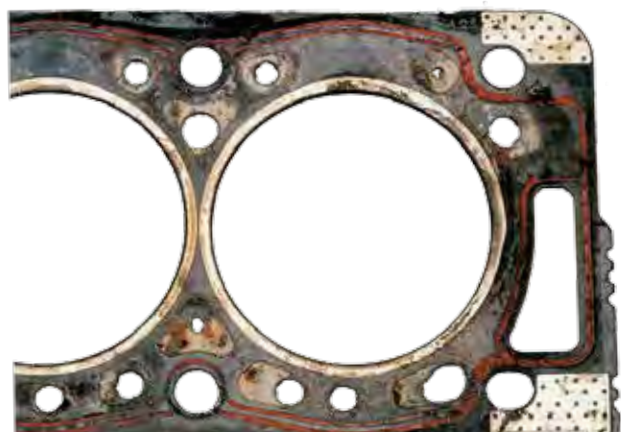

CAUSE

After installation of the engine the cooling system was not vented sufficiently. The engine overheated because the coolant temperature was too high. Evaporation caused the soft material of the gasket to swell in the water duct area. As a result, the soft material of the gasket became detached from the metal carrier.

OTHER POSSIBLE CAUSES

- Functioning of the cooling circuit was restricted by water pump or thermostat
- Water circulation in the cooling system (e.g. in the radiator) was restricted due to lime deposits
- Use of coolant additive that was not approved by engine manufacturers

MEASURES

After installation, ensure that the cooling system is vented properly.

Damage symptoms and causes of oil and coolant leakage

Careful inspection: where is the leak?

Many complaints that are blamed on the gasket were often caused by some other factor, e.g. crankcase ventilation lines, the boost pressure tube or misaligned components (timing gear case on the cylinder block, etc.). Before assuming that the gasket has caused the damage, the technical surroundings of the engine should be inspected closely. For instance, fan wind or an airstream can blow oil or water away from where it actually originated. The gasket is then blamed for not providing a proper seal.

Cylinder head installed professionally?

After repairs, complaints about oil and coolant leaks are very common. In many cases, however, such leaks were caused by improper installation of the cylinder head. For instance, if the installation instructions were not followed in detail.

If the gasket is not aligned when the cylinder head was mounted, because the centering pins or sleeves are missing for example, leaks can occur. This occurs if the sealing elements of the cylinder-head gasket are not positioned exactly where they were designed to be. Cylinder-head gaskets installed in this way can often be recognized because of bolt through-holes having been deformed. Leaks are particularly common in pressurized oil bores if the cylinder-head gasket is misaligned.



Cylinder-head gaskets for commercial vehicles: it's all about the groove

Various gasket designs are used in commercial vehicle engines. In most cases, they are metal-elastomer gaskets with mounted or vulcanized elastomer sealing elements. Depending on the design, there are recessed grooves in the cylinder block and cylinder head, and sizing is such that the sealing elements operate reliably under all engine operating conditions.

With these types of gaskets it is particularly important for the grooves to be cleaned carefully before installation in order to remove any dirt or residues. If this is not done, leaks will occur.

Damage in the form of crushed elastomer sealing elements can even arise during the installation procedure if care is not taken when mounting the cylinder head on the cylinder block.

AN ACTUAL CASE

A truck engine developed a water loss that could not be detected from the outside. Cause: the cylinder liner had a porous area that was only visible under a microscope. When the engine was running, water got into the combustion chamber and evaporated. The cylinder-head gasket was not to blame in this case either – the cause was a material flaw in the form of a blowhole in the cylinder liner.



It's the surfaces that are crucial

The condition of the component surfaces has a major impact on the sealing function. The various types of cylinder-head gasket designs such as metal/soft material, Metaloflex™ metal layers and metal-elastomer, mean that component surfaces have to meet defined requirements. For instance, the surfaces of the cylinder block and cylinder head have to be machined very finely and may not exhibit any waviness. The transitional areas from one component to another, for instance when a timing gear case is flanged, are particularly crucial. Special care is required in order to ensure that at the joint there is no raised edge or distortion that could prevent a force-locked seal.

Only use approved antifreeze/anti-corrosion agent

When considering all these factors that cause a loss of fluid, the chemical impact of the fluids themselves must also be taken into account. This includes antifreeze and anticorrosion agent. Many fluids available on the market have not been approved by the engine manufacturers. Due to aggressive additives they destroy the sealing material and cause leaks. So-called leak stoppers that are added to the cooling water have the same effect. Chemical plasticizers cause the sealing materials to swell. After a short period of time this process destroys the gasket. Additional sealing compounds that are applied to cylinder-head gaskets can also have a negative impact because they can interfere with the sealing function of the sealing elements integrated into the cylinder-head gasket. Generally speaking, Elring cylinder-head gaskets are designed in such a way that they do not require any additional sealing compounds.



Damage symptoms and causes of oil and coolant leakage

1. Failure caused by an oil leak, sealing element destroyed during installation of the cylinder head (truck)

DAMAGE SYMPTOMS

The elastomer sealing elements have been pressed away from the carrier plate and have been cut or torn.

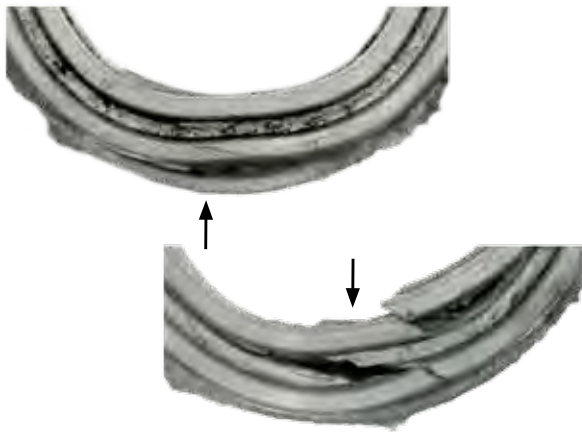

CAUSE

Due to incorrect positioning, the cylinder head was mounted more than once during installation. As a result, certain areas of the sealing element were compressed excessively or cut by the edges of the cylinder head.

OTHER POSSIBLE CAUSES

- Sealing element was pressed away by gas blow-by
- Sealing element was excessively compressed due to insufficient liner protrusion

MEASURES

Take great care when preparing and performing the installation work. If the cylinder head needs to be mounted a number of times, the gasket must be inspected for damage.

2. Failure caused by an oil leak, sealing compound on sealing element (truck)

DAMAGE SYMPTOMS

The elastomer sealing element has been pressed away from the carrier plate. The sealing groove contains particles of dirt.



CAUSE

Additional sealing compound was applied to the metal carrier plate. As a result of vulcanization the elastomer sealing element was subjected to additional pressure and pushed away. The result was an oil leak. The damage was accelerated by deposits of dirt particles.

OTHER POSSIBLE CAUSES

- The sealing element was damaged during installation/ mounting of the cylinder head.

MEASURES

Before installation, check the condition of the sealing surface very carefully and make sure the cylinder head is flat. If necessary, have it faced by a qualified contractor. Do not use sealing compound. Make sure oil is changed regularly.

Damage symptoms and causes of mechanical factors

Damage due to parts becoming detached

Serious damage can be caused to the engine by the mechanical action of parts becoming detached. For this reason the cylinder-head gasket naturally also exhibits substantial signs of damage.

1. Failure of the cylinder-head gasket due to a loose precombustion chamber

DAMAGE SYMPTOMS

The variable tumble control system plate area of the multilayer metal cylinder-head gasket is badly damaged due to mechanical action.



CAUSE

The swirl chamber for the first cylinder became detached during operation and fell into the combustion chamber. The result: serious damage to the cylinder head, valve train and pistons.

OTHER POSSIBLE CAUSES

- Protrusion at the turbulence chambers did not conform to the manufacturer's specifications.

MEASURES

Before the cylinder head is mounted, it is absolutely essential to check turbulence chambers for secure fit and protrusion.

2. Failure of a commercial vehicle cylinder-head gasket due to installation error

DAMAGE SYMPTOMS

The metal combustion chamber eyelets of the cylinder-head gasket were completely compressed together internally by the collar of the liner. The collar of the liner was blasted away by the extreme forces when starting the engine – the result was serious engine damage.



CAUSE

During installation of the cylinder-head gasket the combustion chamber diameter of the cylinder-head gasket fitted was not checked. The gasket used had a through-hole design that was similar to that of the cylinder-head gasket removed, but the combustion chamber diameter of the replacement gasket was smaller.

OTHER POSSIBLE CAUSES

- The cylinder-head gasket was not an original Elring but an inferior-quality replica that was too thin.

MEASURES

Before installation, place the cylinder-head gasket on the collar of the liner and check to make sure it fits without having to apply force.

Damage symptoms and causes of irregular combustion process

„Knocking“ damages the gasket

Damage to cylinder-head gaskets as a result of an irregular combustion process is very common in practice.

Very often this is associated with knock damage in gasoline engines, resulting in uncontrolled combustion processes.



This is problematic because of the resulting thermal and mechanical overload on the components. The cylinder-head gasket is one of the most susceptible engine parts and it can only withstand this extreme stress for a short period of time. The uncontrolled combustion process generates shock waves accompanied by an extremely rapid increase in pressure (over 100 bar) and also high temperatures (well over +3,700°C). In many cases, crushed combustion chamber eyelets are evidence of cylinder-head gaskets affected by knock damage.

POSSIBLE CAUSES

- Use of non-anti-knock fuel with an insufficient octane rating
- Sparkplugs with incorrect heat rating
- Compression ratio too high
- Gasoline mixed with the diesel

IN DIESEL ENGINES

- Start of delivery for fuel injection not adjusted properly
- Fuel dribble from injection nozzles
- Thickness of cylinder-head gasket installed is incorrect
- Piston protrusion not taken into account when selecting the cylinder-head gasket
- Poor fuel quality

1. Failure caused by uncontrolled combustion process acting on multilayer metal gasket

DAMAGE SYMPTOMS

Onset of black discoloration in the sealing web area of the functional layer points to the destruction process, triggered by unprofessional chip tuning.

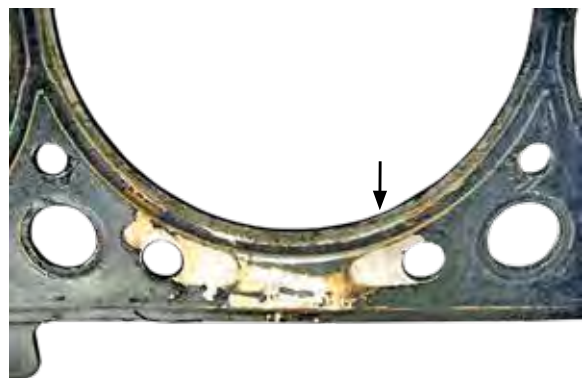

CAUSE

An uncontrolled combustion process caused high-frequency vibrations. The resulting shock waves destroyed the sealing web.

OTHER POSSIBLE CAUSES

- Poor fuel quality (insufficient octane rating)
- Compression ratio too high
- Fuel injection system
- Engine tuning

MEASURES

Comply with the installation specifications. Follow the general installation instructions issued by the engine manufacturer.

2. Failure of the cylinder-head gasket due to knock damage

DAMAGE SYMPTOMS

Recesses and deformations can be clearly seen on the metal combustion chamber eyelets. This causes the eyelets and the soft material to fuse. At these points the bare metal of the combustion chamber eyelets can usually be seen and the soft material shows traces of burning.



CAUSE

Engine tuning (ignition advance) was not performed in accordance with the manufacturer's instructions. That subjects the engine to thermal and mechanical overload. Uncontrolled combustion generates shock waves with extreme pressures and high temperatures, thus exposing engine parts to undue stress. The most frequent damage is caused to pistons and the cylinder-head gasket.

OTHER POSSIBLE CAUSES

- Poor fuel quality (insufficient octane rating)
- Compression ratio too high
- Sparkplugs with incorrect heat rating or defective sparkplugs
- Incorrect ignition timing

MEASURES

Comply with the installation specifications. Check engine tuning immediately after installation.

Professional installation of the cylinder-head gasket in seven steps

Please follow the general installation instructions issued by the engine manufacturers

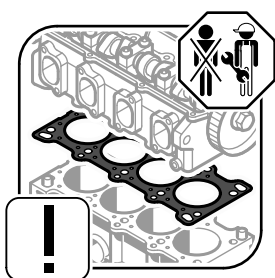

1. Carefully clean and degrease the **SEALING SURFACES** of the components (cylinder head / cylinder block), removing any coating residues or gasket remnants.

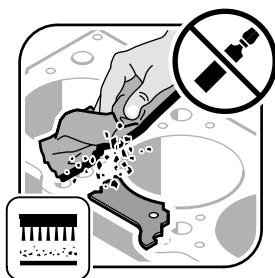

2. Clean the **THREADED HOLES** for the cylinder-head bolts to remove dirt and oil. Inspect threads for damage and make sure the bolts turn smoothly.



3. Inspect **COMPONENT SURFACES**:

- Remove any raised material with an oil stone
- Determine the flatness of components over the entire component using a straight edge: longitudinally = 0.05 mm, transversely = 0.03 mm Scores must be removed (have the surfaces faced by a qualified contractor)

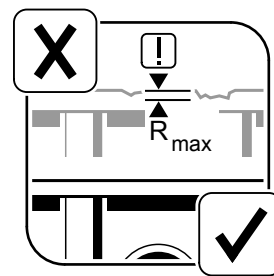
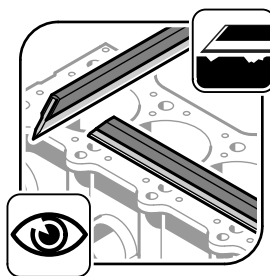

R_z	15 - 20 μm	11 μm	11 - 20 μm
R_{max}	20 - 25 μm	15 μm	15 - 20 μm

4. Center the **CYLINDER-HEAD GASKET** on the engine block (without applying any additional sealing compound):

- Make sure the coating is not damaged

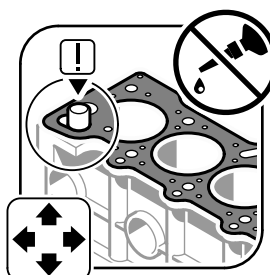

5. MOUNT THE CYLINDER HEAD

- Avoid damaging the sealing surface with scratches
- Look out for any residues such as metal swarf that can emerge from the cylinder head and land on the gasket

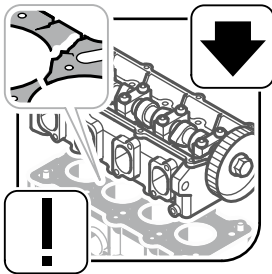

7. TIGHTENING BOLTS

- Follow the tightening sequence indicated in the manufacturer's instructions
- If bolts have to be retightened, follow the retightening instructions

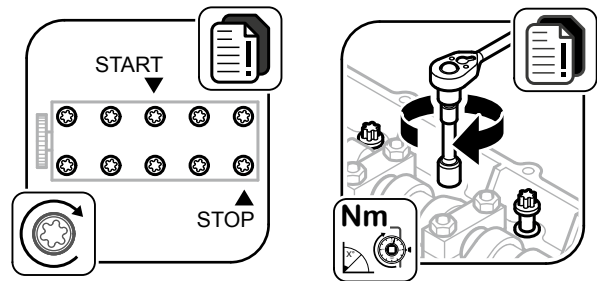

6. CYLINDER-HEAD BOLTS

Recommendations from the automotive manufacturers:

- Always fit new cylinder-head bolts and washers
- Lightly lubricate threads and bolt seat surfaces with oil

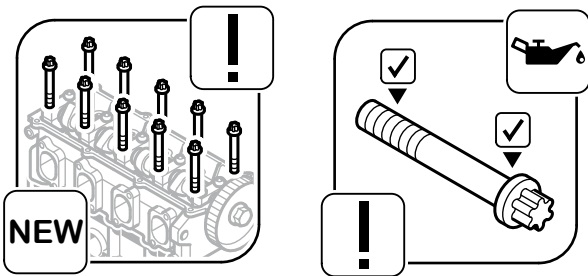

- If a washer is also being fitted, only apply oil between it and the bolt head
- Important: Under no circumstances should the seat surface of the washer be oiled on the cylinder head

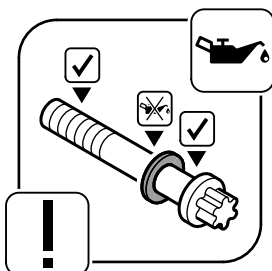

Selection of appropriate cylinder-head gasket for diesel engines

When it comes to diesel engines there is usually a choice of cylinder-head gaskets in various thicknesses. The piston protrusion has to be measured in order to select the correct cylinder-head gasket. The following steps have to be performed with absolute precision. It is essential that the piston protrusion is measured in accordance with manufacturer specifications.

- The measurement points must be above the piston pin axis in order to take account of the effects of piston play (tilt clearance).
- Place the measuring device on the cylinder block gasket surface (must be clean) and zero it out with some pretension.
- Place the measuring device on the piston (must be clean) and determine the highest point by rotating the crankshaft.
- Repeat this procedure for measurement point 2.
- C is the distance between the piston surface at the upper dead center and the joint face of the cylinder crankcase.

These measurements have to be taken for all the pistons. The piston with the largest protrusion is used to determine the suitable cylinder-head gasket.

Refer to the sales document to select the cylinder-head gasket in the thickness needed.

The thickness of the cylinder-head gasket can be verified quite simply by looking at the number of notches or holes.

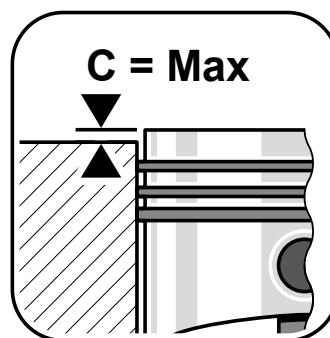
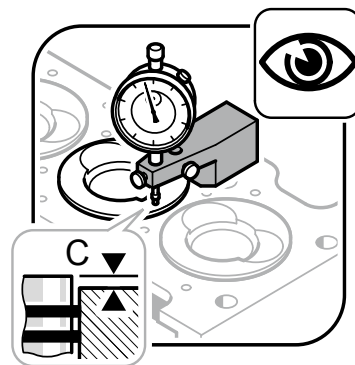
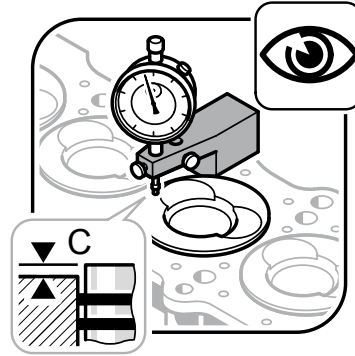



Elring Academy: User-friendly online tool

Keeping your
finger on the
pulse of sealing
technology



Four steps to becoming a Certified Expert

1. Register at www.academy.elring.de
2. Discover the extensive Elring range – 24/7 and around the globe
3. Test your own expertise and complete various exams
4. Receive a personal certificate and take the opportunity to highlight your skills as a Certified Expert



The Elring Academy boasts a vast library that can be accessed around the clock – everything you need at the click of a button. It also includes the full range of technical information about our products as well as installation guides.

You can also look forward to exclusive training material, such as animations and videos specially developed for the Elring Academy. The information provided will help you to expand your knowledge in various fields of sealing/gasket technology and prepare you for the respective exams. Our animated videos offer a professional, step-by-step guide to the various methods of installation.



www.academy.elring.de





Website



Elring Academy



Facebook



YouTube

Elring-Service



Monthly Newsletter



Service Information



Exploded View Drawings



Online Catalog



Elring sealing compound wizard:
finding your product in 3 simple steps.



All data specified has been compiled with great care on the basis of our extensive experience. However, no liability can be undertaken, since sealing can only be successful if the particular circumstances of each individual case are taken into account.

Elring-Service-Hotline



+49 7123 724-799



+49 7123 724-798

service@elring.de

ElringKlinger AG | Aftermarket Division
Max-Eyth-Straße 2 | 72581 Dettingen/Erms | Germany
Phone +49 7123 724-601 | Fax +49 7123 724-609
elring@elring.de | www.elring.com

C510016 04.18 EN



Das Original